



# City of Longview

1525 Broadway  
Longview, WA 98632  
www.ci.longview.wa.us

## Minutes

### Visual Arts Commission

Wednesday, May 18, 2022

5:00 PM

Recreation Office, 2920 Douglas

**NOTICE IS HEREBY GIVEN**, in accordance with RCW Chapter 42.30, that the Visual Arts Commission of the City of Longview, Washington, will be holding a regular meeting via zoom on Wednesday, May 18, 2022 at 5:00 PM. Join Zoom Meeting

<https://us02web.zoom.us/j/6506561397>

Meeting ID: 650 656 1397

Please contact the City Executive Offices at 360.442.5004 48 hours in advance if you require special accommodations to attend the meeting.

1. **CALL TO ORDER**
2. **ROLL CALL**
3. **APPROVAL OF MINUTES**
4. **CONSTITUENT COMMENTS**
5. **BOARD MEMBER COMMENTS**
6. **REPORTS**
7. **OLD BUSINESS**
8. **NEW BUSINESS**

**22-000339 LOWER COLUMBIA CLONEY PARK PAINT PROJECT**

Funding for this project has been made possible by the Lower Columbia College and the Longview Parks and Recreation Foundations. Ray Cooper, Instructor of Art, Design, Visual, and Performing Arts at LCC, will be bringing his advanced painting students to Cloney Park to paint a mural on the skate park elements. The Parks and Recreation Advisory Board recommended the project.

**RECOMMENDED ACTION:**

Motion to recommend the installation of a mural at Cloney Skate Park.

**STAFF CONTACT:**

Jennifer Wills

9. **ADJOURNMENT**

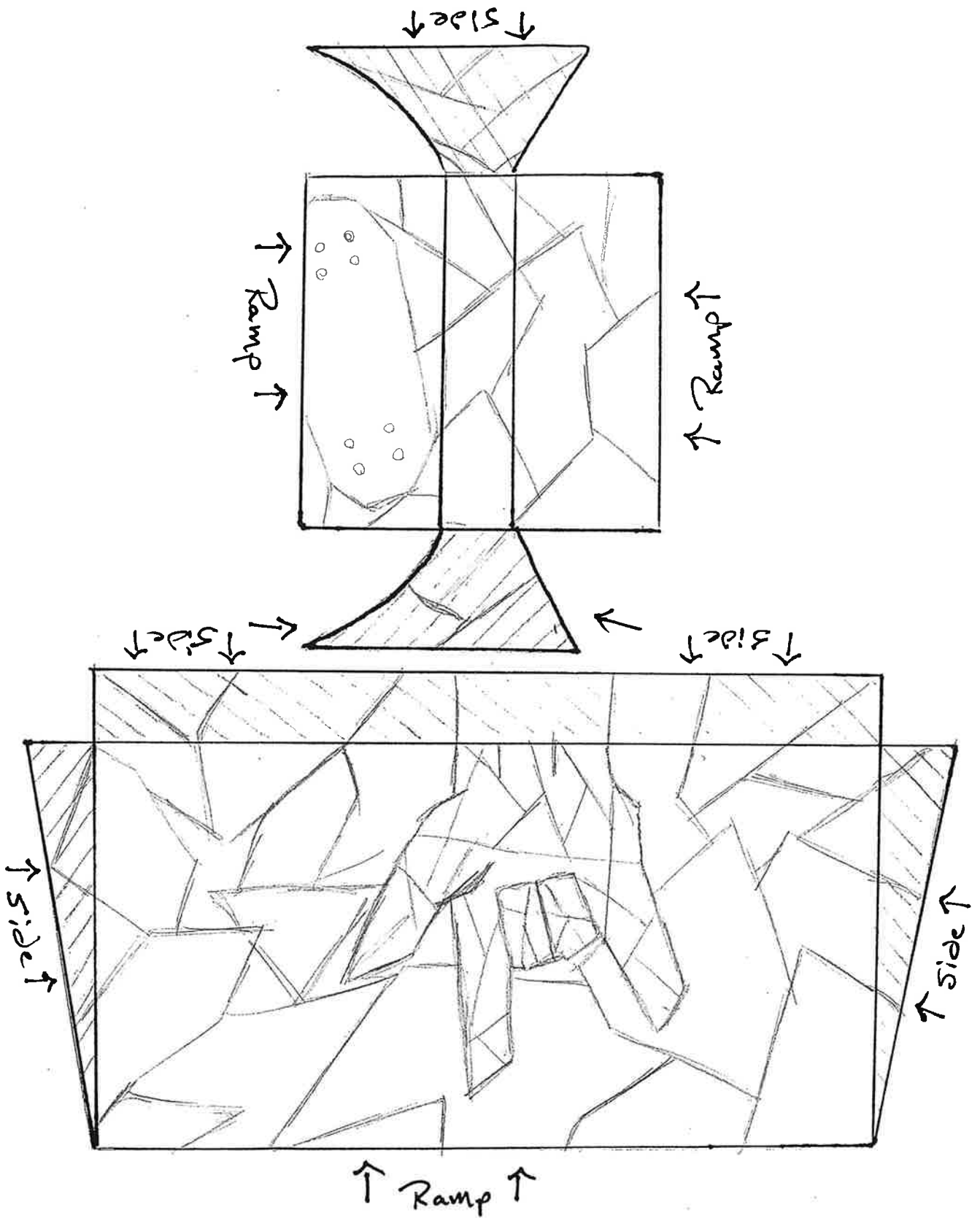

Park Feature 6  
 (Page 1051)

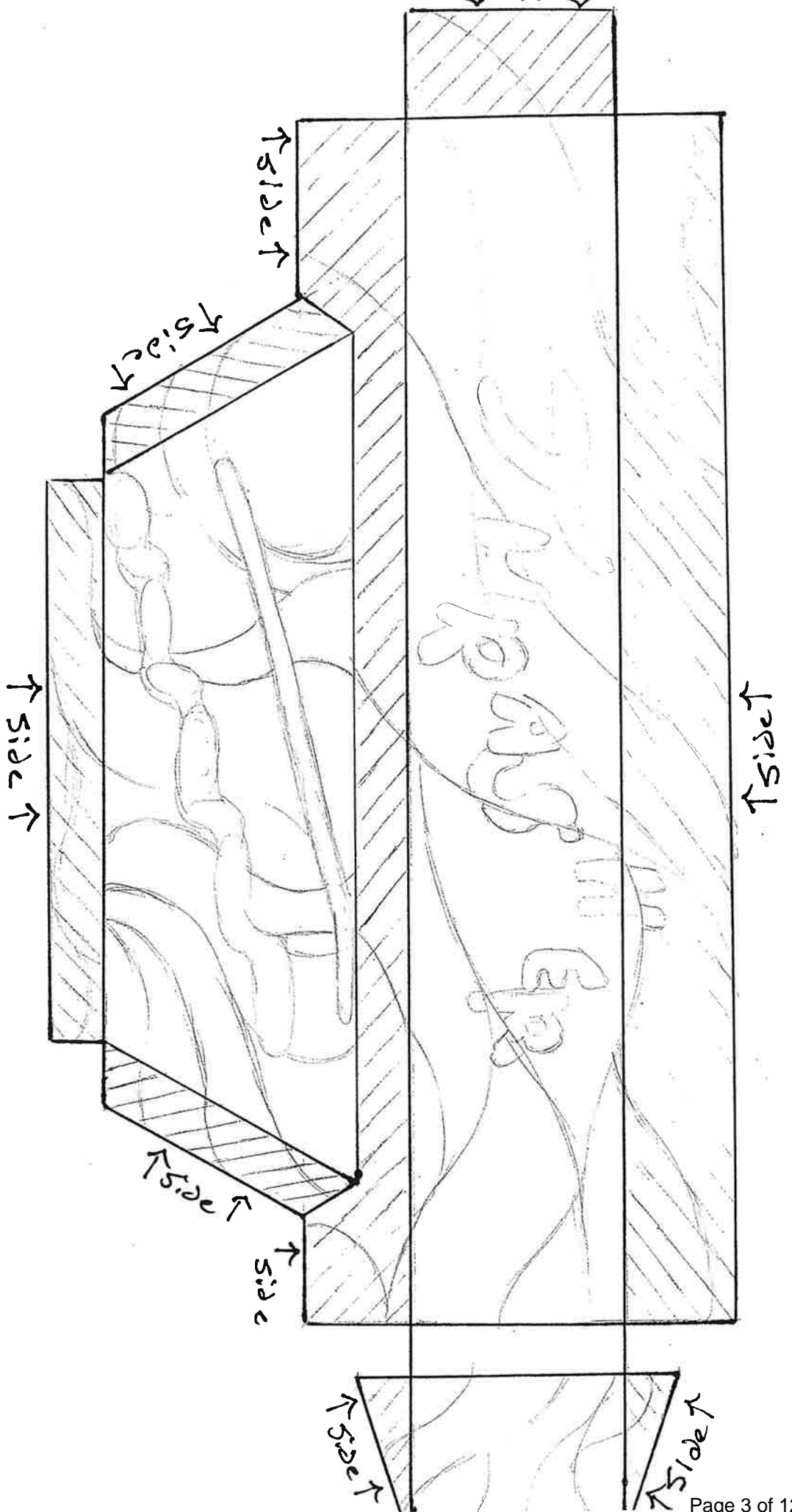

Park Feature 2

(Page 1081)

↑ side ↓

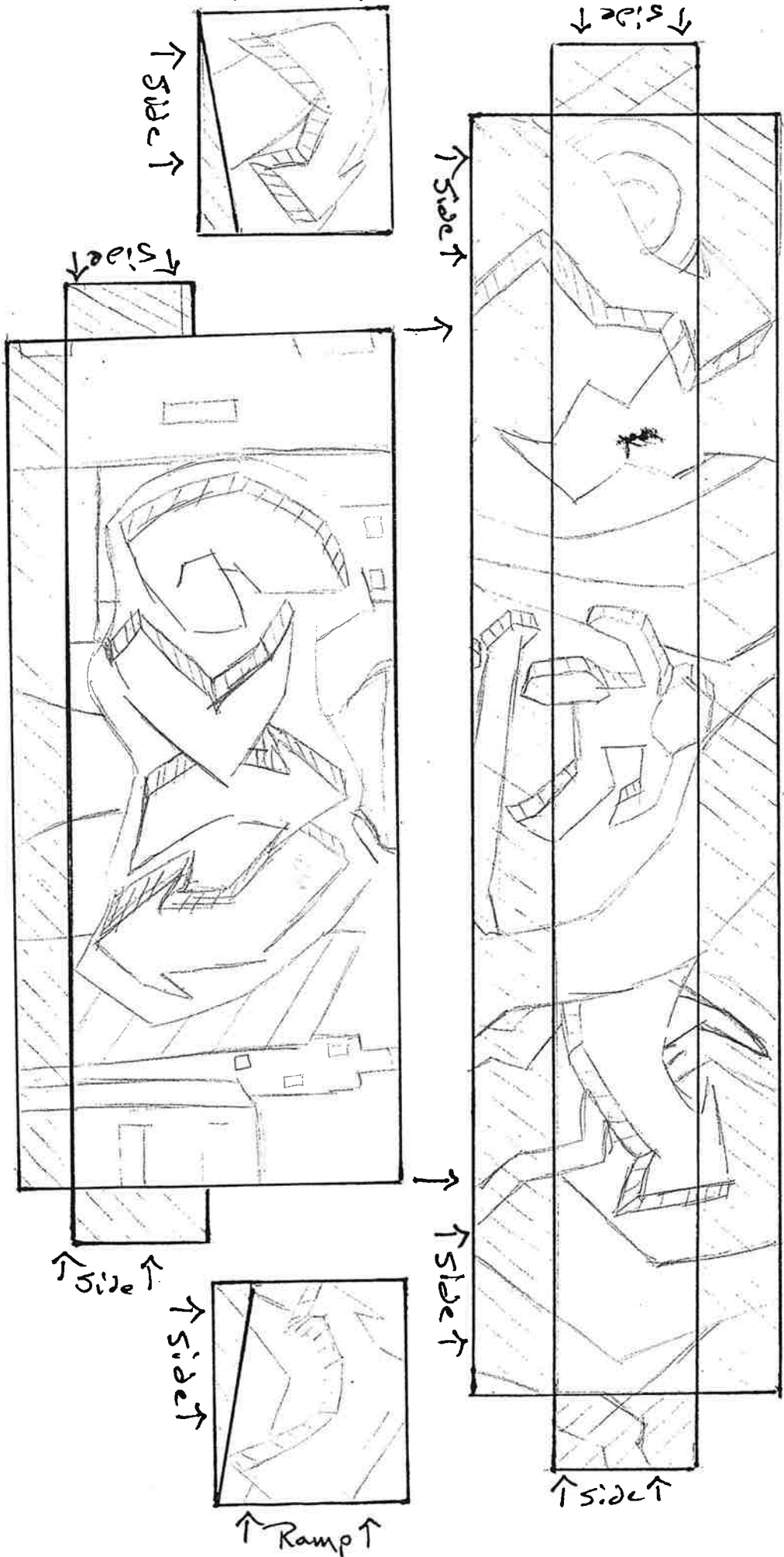

↑ side ↑

Park Feature 1  
(Page 1 of 1)

Park feature 3  
(Phase 2 of 2)

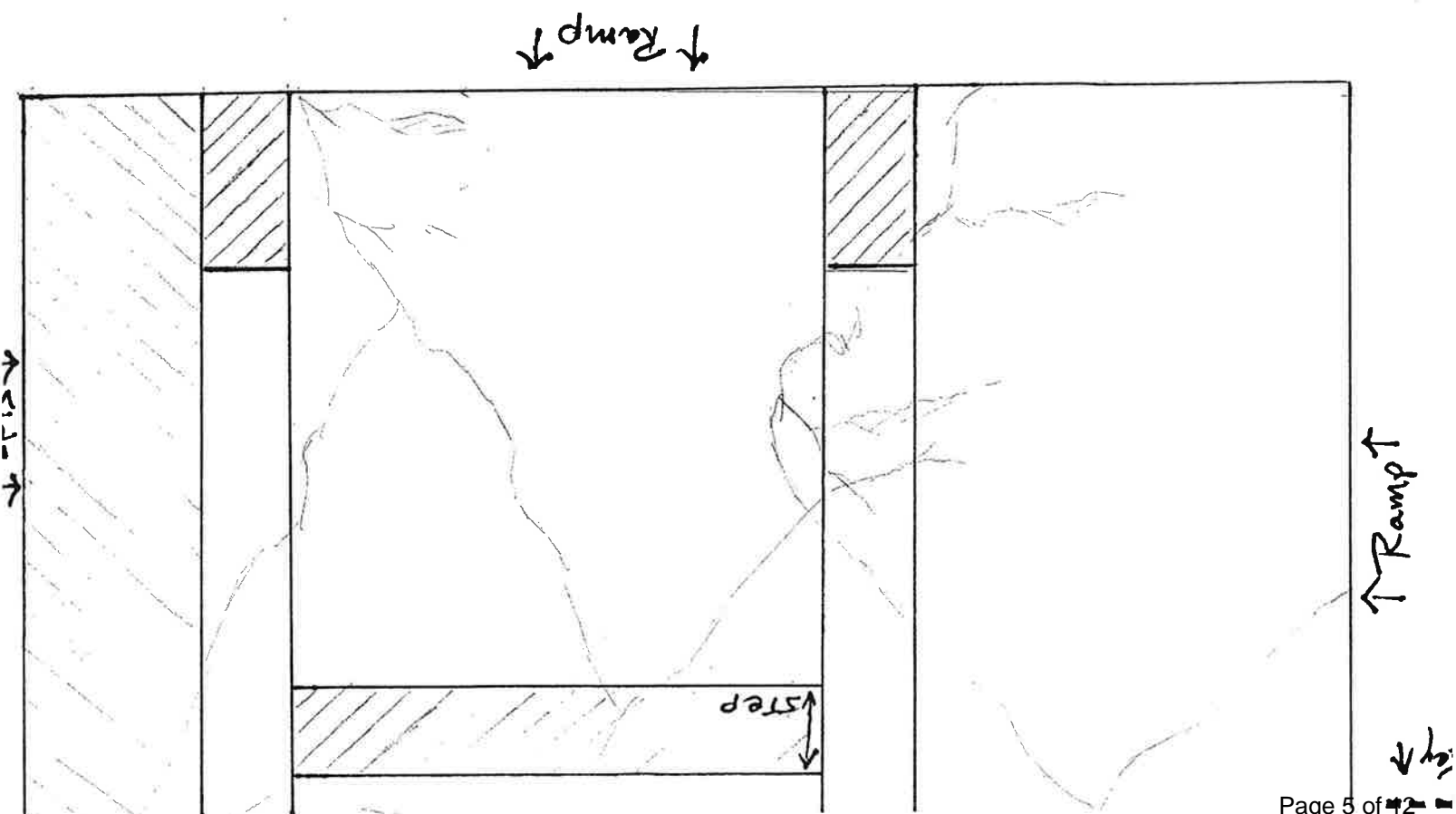

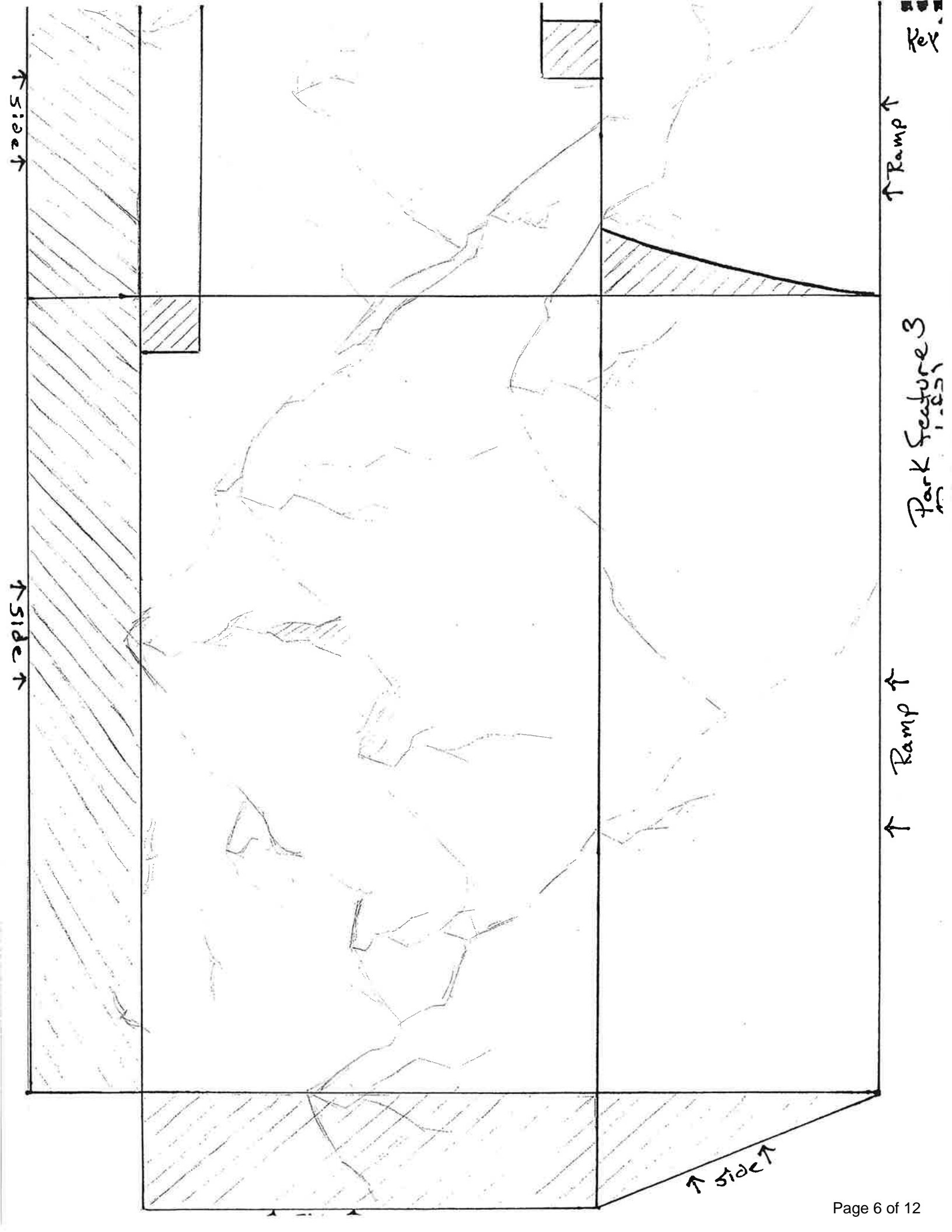

Key

Park Feature 3

Park Feature 4  
(Page 1081)

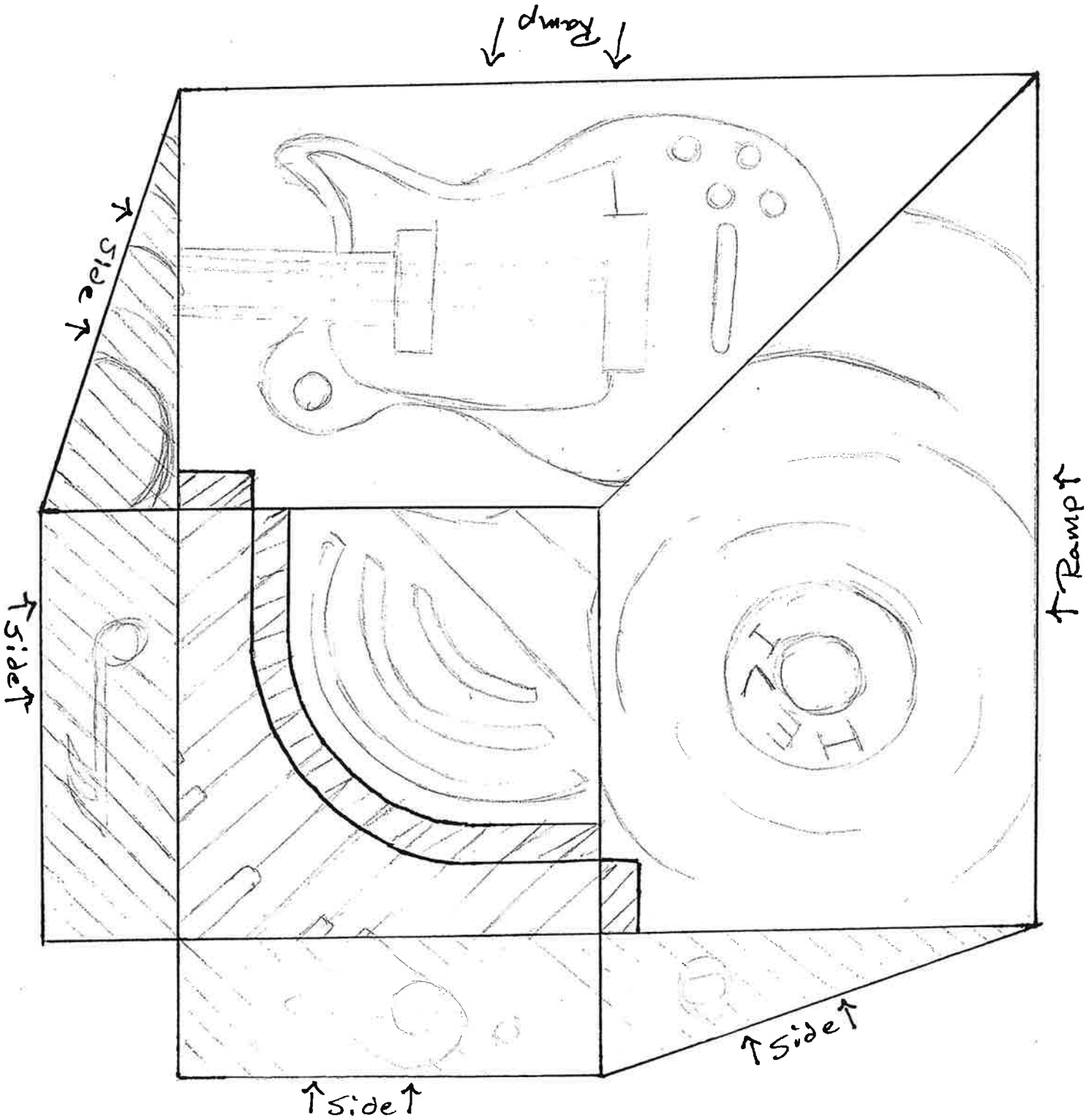

Park feature 5  
(page 1 of 2)

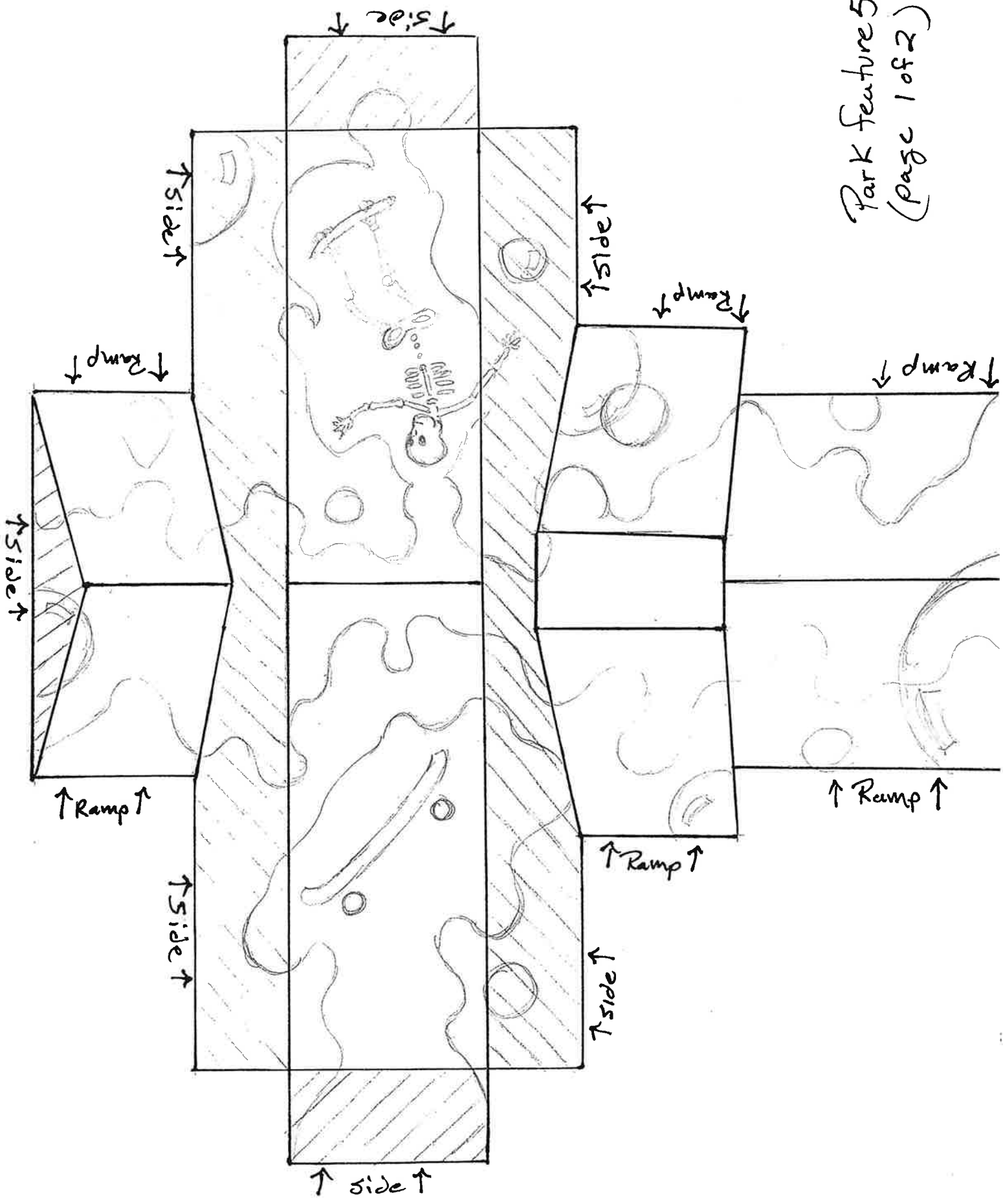

↑ Key ↑

Park Feature 5  
(page 2 of 2)

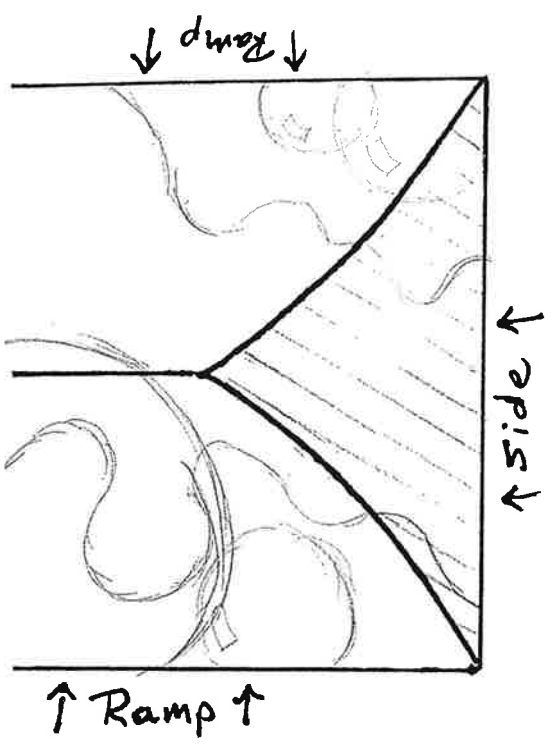

↑ Key ↑

Back feature 7  
(page 1053)

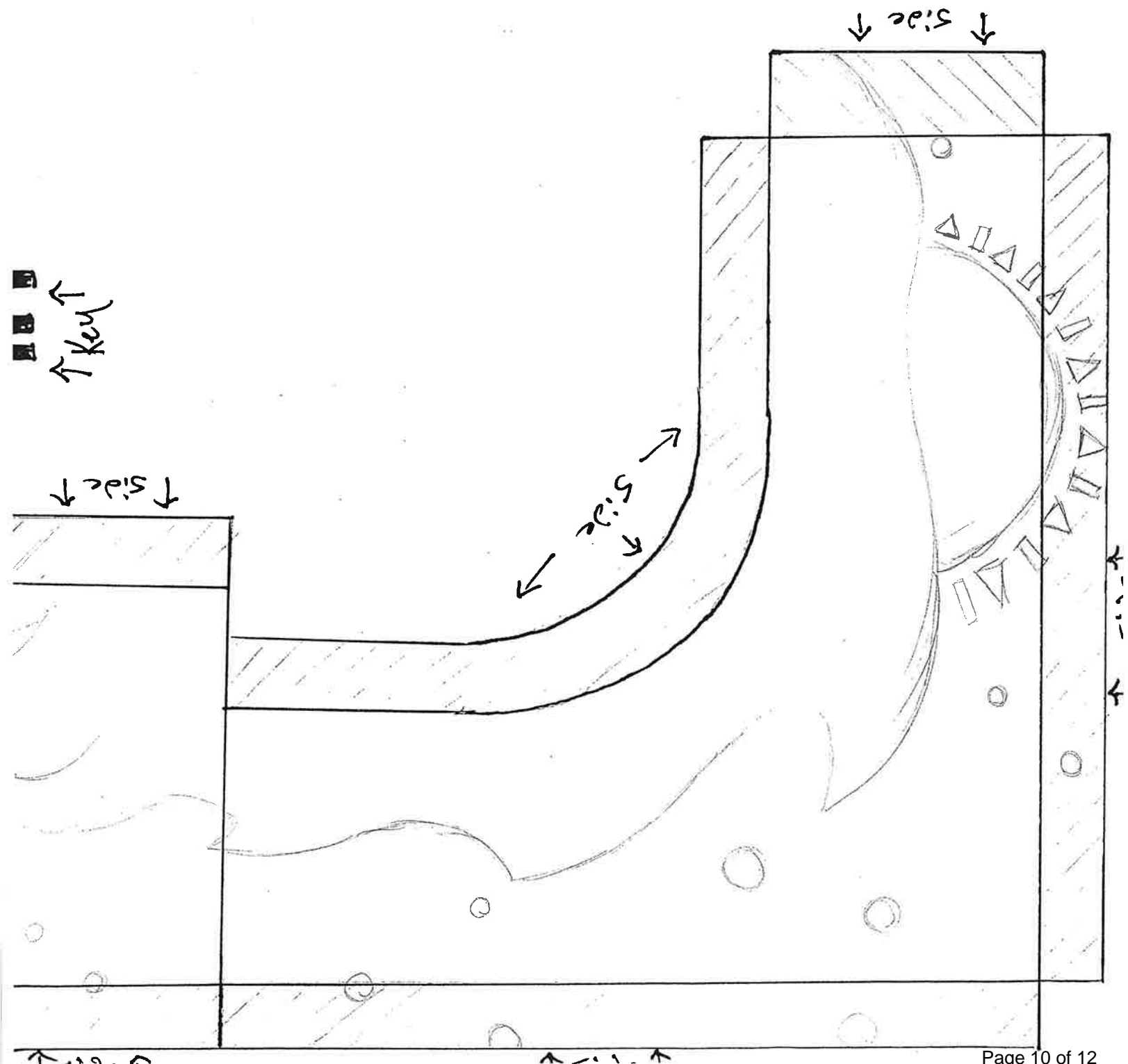

↑ Key ↑

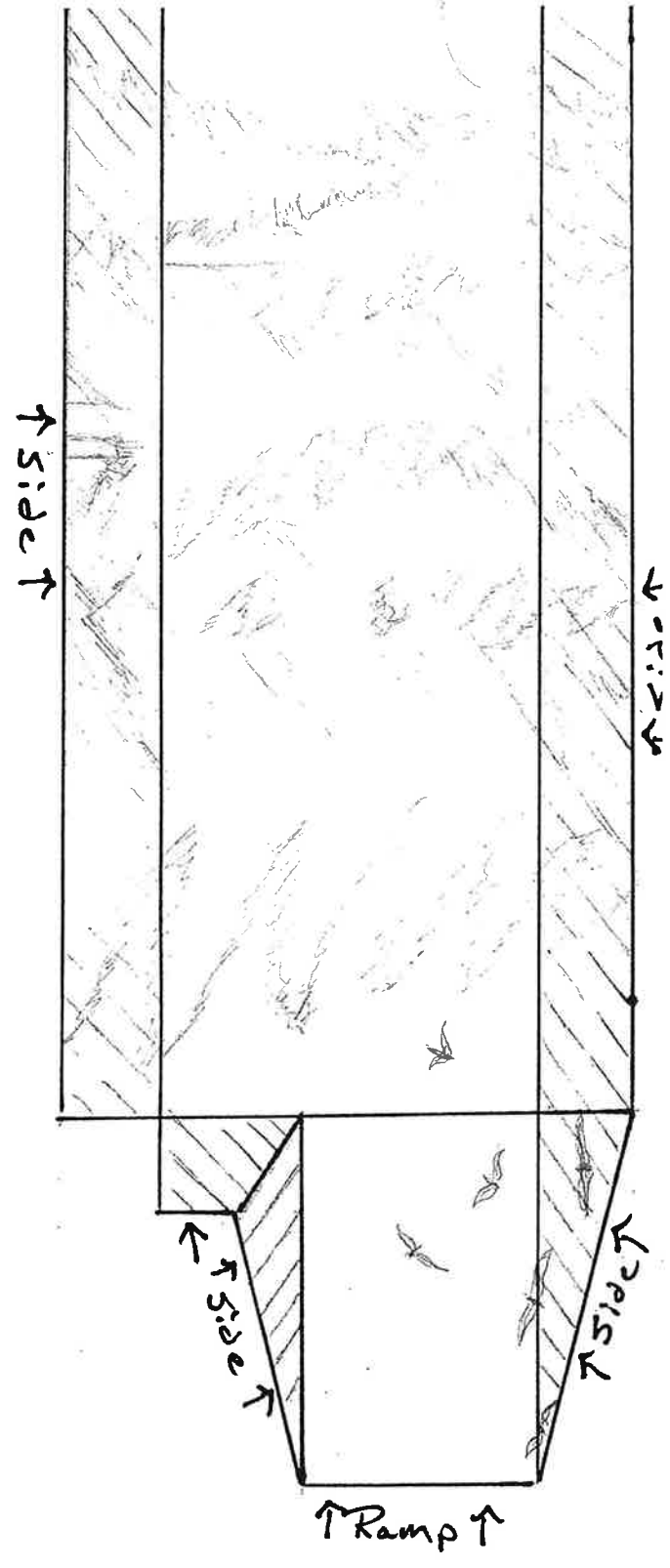

Park Feature 7  
(page 3 of 3)

↑ Key ↑

↑ Side ↑

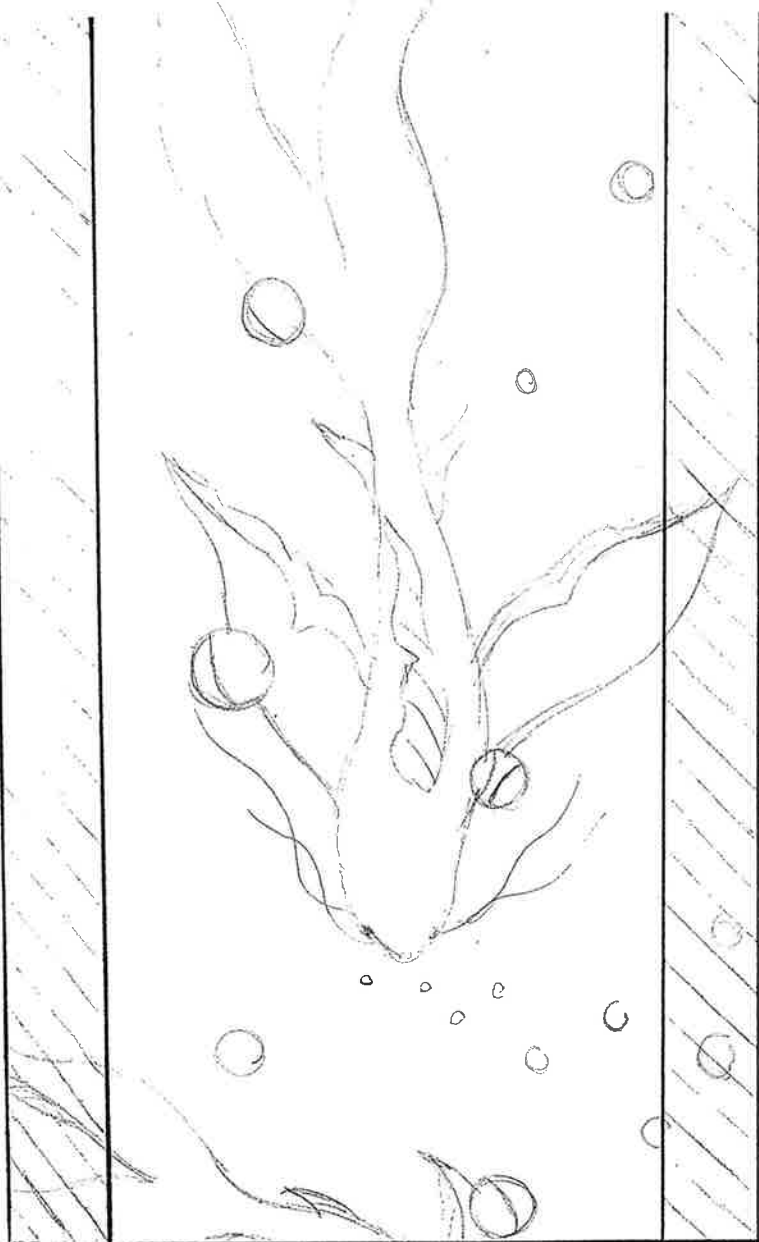

Park Feature 7

(page 2 of 3)

↑ side ↑

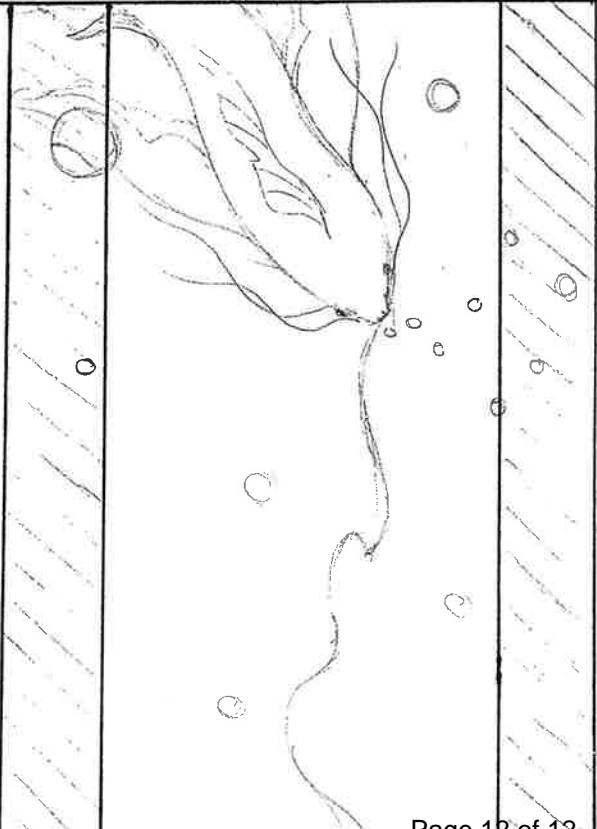

↑ Key ↑